

The Company reserves the right to make such changes to the design or specification of the equipment as it shall see fit. The information contained in this manual is issued for the guidance of users and does not form part of any contract. It is strongly recommended that all users and supervisors familiarise themselves with the contents...

#### PRIOR TO COMMENCING USE OF THE SYSTEM

...and in particular, the section on safety precautions which should be used as a guide to safe operation in accordance with the requirements of the relevant Health and Safety at Work legislation.

### **GOODWIN AIR PLASMA LIMITED**

KERNAN DRIVE  
LOUGHBOROUGH  
LEICESTERSHIRE  
LE11 5JF  
ENGLAND

**Tel No. ++(0) 01509 237369**  
**Fax No. ++(0) 01509 234942**  
**Email. goodplasma@aol.com**

# Contents

1.....	SAFETY	4
1.1.....	General	4
1.2.....	Safety Features	5
1.3.....	Warning Signs	5
1.4.....	Packaging Handling and Transport	5
2.....	INTRODUCTION TO THE PLASMA PROCESS	6
3.....	INSTALLATION	7
3.1.....	Power Supply	7
3.2.....	Earth Requirements	7
3.3.....	Phase Determination	8
4.....	PLASMA AND TORCH CONNECTIONS	9
4.1.....	Connecting the Torch and Plasma Earth Lead to the Power Unit	9
4.2.....	Control of Hand Torch	10
5.....	OPERATION	11
5.1.....	Machine Controls	11
5.1.1.....	warning indicators	13
5.2.....	Power Up Procedure	14
5.3.....	Cutting Procedure	15
5.3.1.....	Starting and Finishing a Cut.	15
5.3.2.....	Cutting With Stand Off.	15
5.3.3.....	Cutting Speed.	16
5.3.4.....	Piercing Thicker Materials with a Hand Torch	17
5.3.5.....	Piercing with a Machine Torch	18
5.4.....	Troubleshooting	19
5.5.....	Consumable Life.	19
5.5.1.....	Intrinsic Life.	19
5.5.2.....	Alignment.	19
5.5.3.....	Transient Damage.	19
5.5.4.....	Operational Damage.	20
5.5.5.....	Electrode “non-starting”.	20
5.6.....	Changing Consumables	21
6.....	TECHNICAL DATA	23
6.1.....	Power Unit	23
6.1.1.....	Electrical Input	23
6.1.2.....	Electrical Output	23
6.2.....	Torch and Hose Set	23
6.2.1.....	Hand Torch	23
7.....	SERVICE INFORMATION	24
7.1.....	The Power Unit	24
7.1.1.....	Circuit Diagram	25
7.1.2.....	Machine Layout	26
7.1.2.....	Diagnostic Indicators.	28
7.2.....	The Torch and Hose Set Repair	29
7.3.....	Maintenance	30
8.....	Torch Blockage	31
8.1.....	Machine Torch	31
8.2.....	Machine Torch exploded View	32
8.3.....	Hand Torch	33
8.4.....	Hand Torch exploded View	34
9.....	Fault Finding	35
10.....	Index	36

# 1. SAFETY

## 1.1 General

Before any cutting operations are started, the user must ensure that the installation and proposed working methods comply with all relevant safety regulations, environmental and electricity standards.

The plasma arc produced at the torch head is a jet of high energy and is potentially dangerous. Users unfamiliar with a plasma arc should seek basic training. Goodwin Air Plasma can offer comprehensive training courses.

In addition, the following points are particularly important:

- a) The mains connection must be properly grounded and the supply lines fitted with fuses of the specified rating. The mains cable must be properly secured and protected from possible damage.
- b) High voltage exists at the torch when power is applied and the pilot arc is struck (up to 95V), and when the main arc is cutting (95V). Under no circumstances should anyone touch the nozzle with power applied to the torch. All adjustments and replacement of parts should be done with the power unit supply isolated. The torch should not be used in excessively wet conditions or if the torch or hose set are damaged in any way.
- c) The mains supply should be isolated from the unit AT THE SUPPLY before removing any panels from the unit. Only authorised service personnel should remove panels.
- d) Keep the work area clear of all inflammable materials. Ensure that any material ejected from the cut is not a hazard to the operator or to others.
- e) Protection is necessary against ultraviolet radiation emitted from the arc. A helmet or shield with shade glass is recommended. Wear gloves and adequate protective clothing where appropriate. Adequate screening should be arranged to protect others in the vicinity or passing by in a similar manner to that required for arc welding operations.
- f) Adequate ventilation or fume extraction to remove the cutting fume and dust is required at all times around any plasma cutting operation. When cutting flat sheet, a shallow water bed cutting table will greatly reduce the fumes and dust which mainly occur below the cut.
- g) The plasma power unit should be positioned on stable level ground and if necessary secured against any unwanted movement.
- h) The operation of this equipment and the plasma cutting process can result in noise levels that could be harmful. The employer should undertake a noise assessment to monitor compliance with relevant legislation.
- i) Material to be cut should be supported in such a way that any material cut from the work piece will not be a hazard and fall onto the user, the equipment, or others in the vicinity.
- j) Care should be taken when manoeuvring the hose set with the hand held torch so that it does not snag on objects or other equipment which may result in damage to the hose set, or topple the objects or equipment. Excessive mechanical tension may result in damage to the hose set connections or to the hose set components themselves.

## 1.2 Safety Features

The plasma unit includes the following features for the safety of the operator:

- \* The body of the plasma torch is earthed.
- \* The continuity of the torch earth and the voltage on the body is monitored.
- \* Cutting current flowing in the supply earth is monitored.
- \* The voltage on the torch nozzle is monitored.
- \* In the event of a faulty condition of the above, the machine will switch off power to the torch.
- \* The access door for the torch connections is interlocked.

The emergency stop procedure is to hit the red emergency stop button located on the lower front control panel.

A tool (10mm spanner) is required to remove the canopy for access to the internal components. Under no circumstances should the canopy be removed whilst the mains supply is still connected. Only suitably trained and authorised personnel should remove the canopy.

## 1.3 Warning Signs

The location of the warning signs fitted to the plasma unit are:

- a) At the front of the machine -  
Warning Open Circuit Voltage 300 volts.

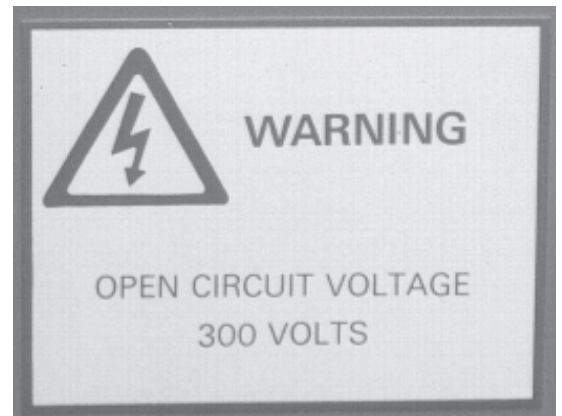

- b) At each rear lower corner of the canopy -  
Warning Disconnect the Mains Supply.....



These should be maintained in a legible condition.

## 1.4 Packaging Handling and Transport

Should the plasma unit need to be shipped, we recommend re-use of the original packing crate. Also:-

- a) That the hose set be disconnected to prevent any damage to the hose set / plasma connections.
- b) That the control panel is adequately protected against potential damage.
- c) Any lifting should be done using the eyebolt located in the top of the canopy together with certified lifting equipment (not supplied). Precautions should be taken to prevent rotation about the eyebolt.
- d) The plasma unit should be shipped and stored in the upright position to avoid any heavy internal components breaking free from their mountings.
- e) Storage should be undercover, preferably in a clean dry environment.

## **2. INTRODUCTION TO THE PLASMA PROCESS**

The plasma process is created by passing a stream of clean ionised air, provided by an oil free compressor, through a NOZZLE in the torch. The air stream is ionised by a PILOT ARC, initiated by a HIGH FREQUENCY unit (HF Unit) which passes from the ELECTRODE to the nozzle when the torch is activated. When the PILOT ARC is brought close to the work piece, MAIN ARC is TRANSFERRED to the work piece as a jet of high energy which rapidly melts any metal with which it makes contact, providing fast cutting, low residual heat input, and low material distortion.

The electrode and nozzle are cooled by air (and water in water cooled torches), and as the air is passed through the nozzle it is caused to swirl around the arc by a SWIRL BUSH to aid stability of the arc.

The HF unit operates automatically to establish an arc when power is applied to the torch and it ceases to operate when the pilot or main arc is established.

### 3. INSTALLATION

May be carried out by a competent electrician. No specialist tools are required.

#### 3.1 Power Supply

The power unit is provided with a length of flexible cable which must be connected to a 3 phase and earth electrical supply. The supply should be fitted with fuses or circuit breakers of appropriate rating and a means of isolating the power unit from the supply should be provided. A plug should be fitted if appropriate. The machine is phase/rotation sensitive.

The power unit has power factor correction capacitors fitted as standard. It must be noted that when the unit derives its power from a generator, the power factor correction may disturb the generators' automatic voltage control. If recommended by Goodwin Air Plasma, the power factor correction circuit can be disconnected however this will increase the input current demand.

Refer to the rating plate on the machine and Technical Data section 6.1.1. for the correct voltage and current requirements.

#### 3.2 Earth Requirements

The installation should be arranged such that the only path to earth (or ground) from the work piece is by way of the plasma earth lead connected to the front of the machine.

Where the material to be cut forms part of the structure which is earthed or grounded to the mains electrical supply system, then the cutting current could flow through that route rather than the plasma earth lead to the machine. Always ensure that there is a good connection between the work piece and the machine via the plasma earth lead as a poor connection will cause excessive current in the mains supply earth which will create a current trip fault condition (see section 7.4 fault finding).

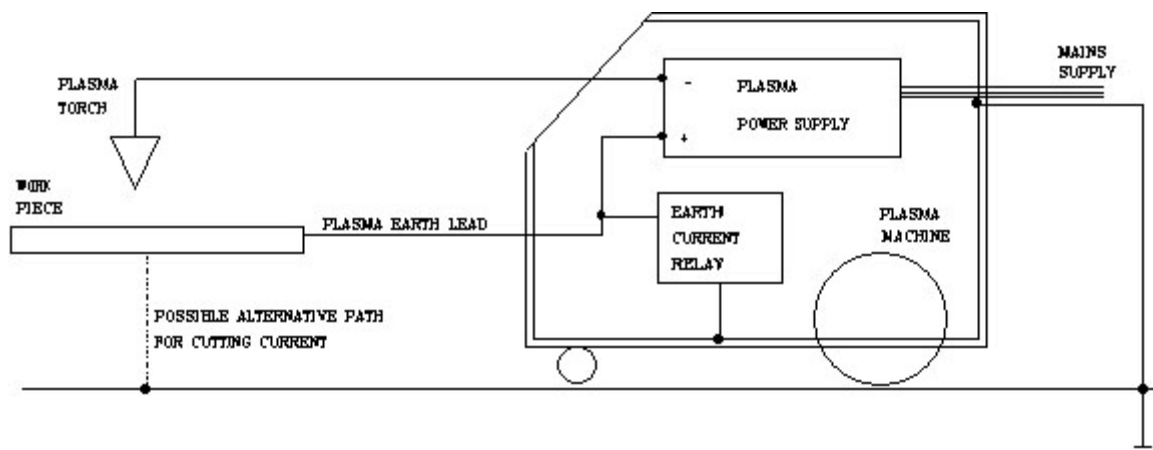

In installations where it is not possible to avoid earth current trips, even though a good cutting current earth path has been ensured, it will be necessary to check that the alternative mains earth paths are substantial enough to carry higher currents than the current trip setting of 10 amps without causing damage, as where the cutting earth is not connected to the work piece at all, this would be the full cutting current. If the earth paths are not substantial they must be upgraded or re-routed to avoid the possibility of damage. Once the necessary checks and precautions have been taken, the earth current trip circuit may be disabled by means of the switch on the Earth Current Relay (ECR) located inside the power unit.

### 3.3 Phase Determination

Connect the torch to the machine (see section 4).

Fill the water system with distilled water.

**Note.** To avoid damaging the water pump the machine should not be run without water in the system, also, the machine should not be run for more than a few seconds without a torch connected to the machine.

Switch on the machine by rotating the main isolator and pressing the on/off button ensuring the access door is closed and the emergency stop switch is unlatched.

Correct phase connection is determined by checking that the cooling air flowing through the power unit is from the front panel to the rear of machine. Also, the water return flow, with a torch connected, can be seen as a jet of water across the filler opening once the filler cap is removed. If these conditions are not correct, change two of the three phase connections at the power supply and check again.

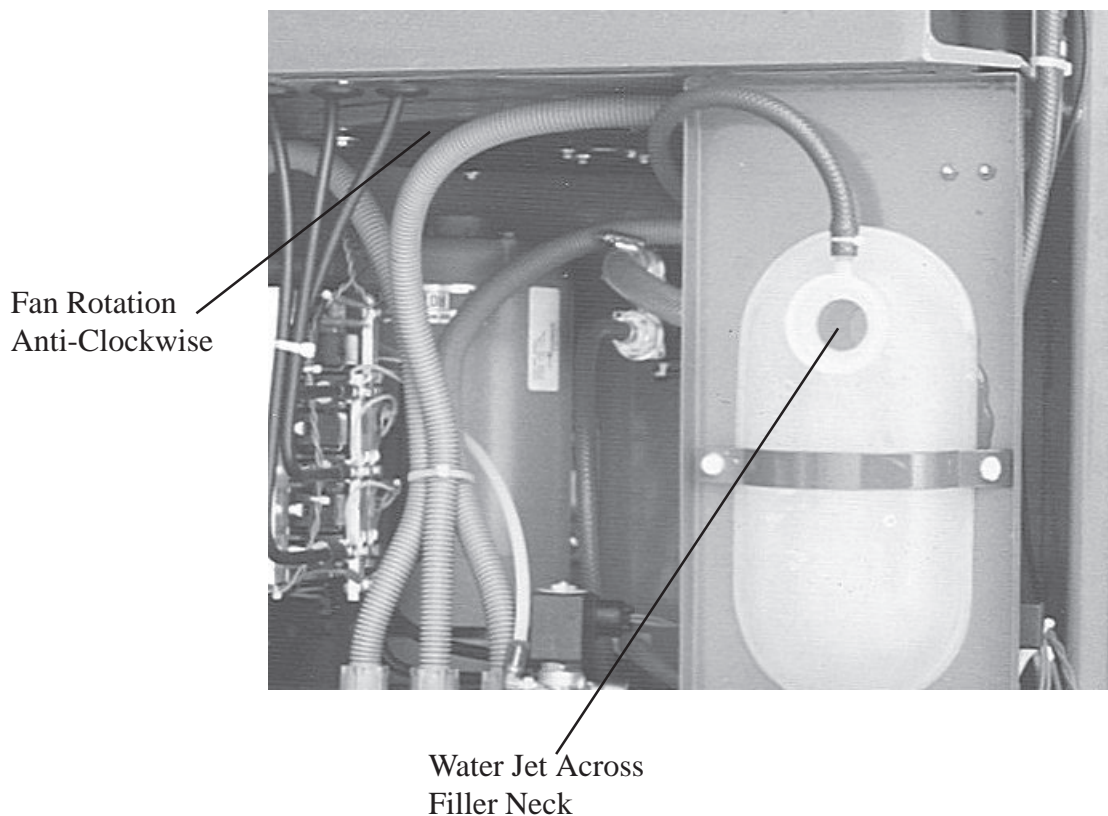

If there is any doubt regarding installation, consult your distributor or Goodwin Air Plasma.



## 4. PLASMA AND TORCH CONNECTIONS

### 4.1 Connecting the Torch and Plasma Earth Lead to the Power Unit

**Note.** Do not run the power unit without the torch connected.

The connections to the power unit are located behind the drop down access door at the front of the unit. The torch hose set must pass through the aperture below the door before making the connections. Care must be taken to obtain good connections.

Torch connection to the power unit is made by a composite hose set.

Water supply line	-	Blue hose with short push in connector.
Water return line	-	Blue hose with long push in connector.
Air and Power line	-	Black hose and orange cable with screw fitting.
Pilot Arc/Torch earth line	-	Black Co-axial cable with plug and screw collar.
Pilot earth/control line	-	White 3 Core cable with 3 pole plug.

The plasma earth lead is connected via the push in and twist clockwise socket.

**Note.** The access door is interlocked with the control circuit hence needs to be shut before the power unit will operate.

The water fittings cannot be fitted incorrectly although the return line (long) will fit in the supply outlet (short) for back flushing the torch. To remove the water hoses, push the water connector collars to release (both together to avoid loss of water).

When first switching on, allow enough time for the water to circulate through the system. A solid flow of water should be seen across the filler orifice when the filler cap is removed, top up the header tank as required. Use only distilled or de-ionised water. (See section 7.1 regarding use of methanol in freezing conditions).

#### DIAGRAM TO SHOW HOSE SET CONNECTIONS

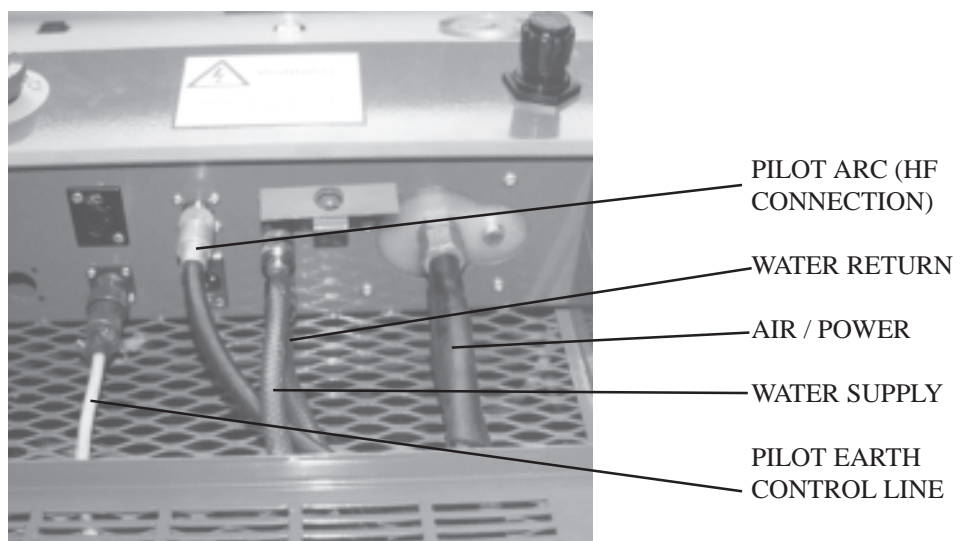

VIEW FROM BELOW

## 4.2 Control of Hand Torch

The hand torch is provided with a press on / release off control switch on the handle for operation of the plasma arc.

**Note.** Cooling air will flow through the torch at all times when the machine is switched on.

If a hand torch is to be used in conjunction with a mechanical manipulator or tractor unit etc., when the operation of the handle mounted press on / release off control switch will not be possible, plug the remote control (optional extra) switch unit into the remote control socket as for the machine torch.

## 5 OPERATION

### 5.1 Machine Controls

The front panel of the machine provides a range of displays and control gear to ensure correct operation

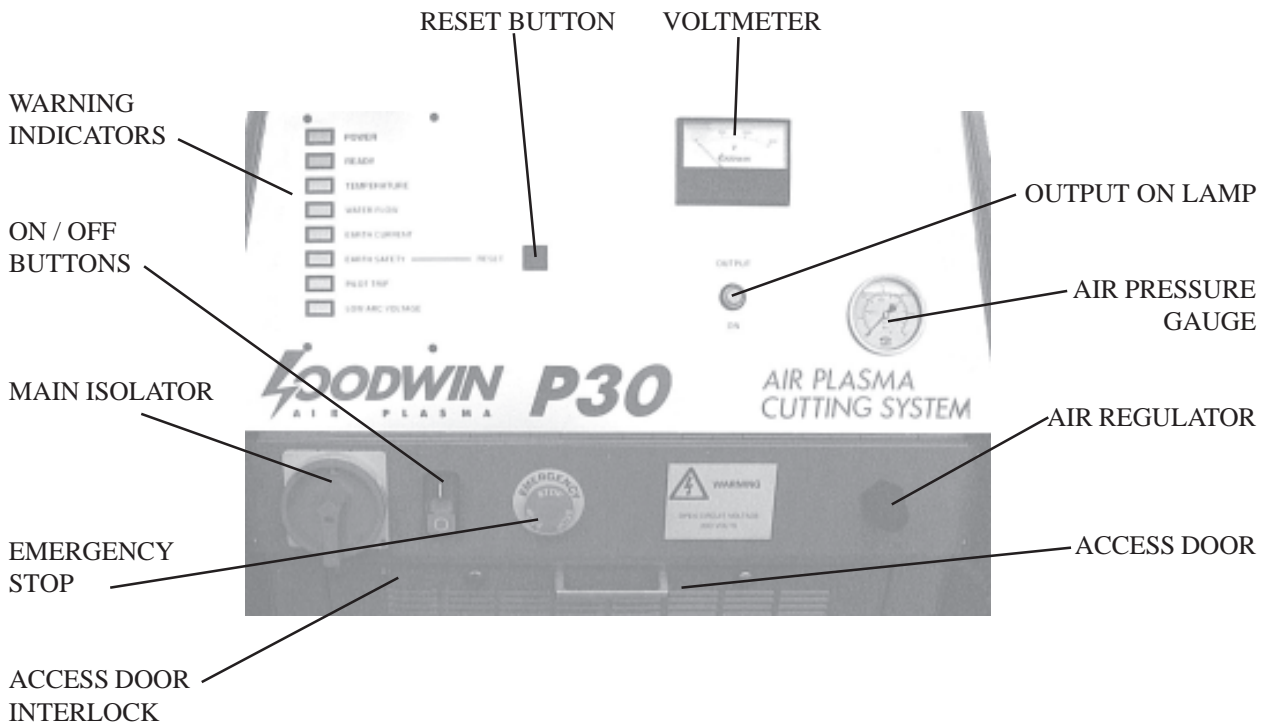

#### ON / OFF BUTTONS

Switches auxiliary circuits on and off. ie Compressor, water pump, cooling fan and control circuits

#### MAIN ISOLATOR

Isolates machine from mains supply. It may be padlocked in the off position.

#### EMERGENCY STOP

Switches machine off. The switch latches mechanically and must be rotated to release.

#### DOOR INTERLOCK

If the access door is open the machine will not work and the ready indicator will not be illuminated.

## HOSE CONNECTIONS

See section 4. Connecting the torch to the power unit.

## VOLTMETER

Indicates the arc voltage.

Typical values would be:	Power applied to torch but no arc	300v
	For Pilot Arc	250 to 280 volts
	For Main Arc	120 to 180 volts

## OUTPUT ON LAMP

Indicates that power is applied to the torch.

## RESET BUTTON

Resets earth current, earth safety, low arc voltage and water warning circuits.

## AIR PRESSURE GAUGE

Displays the back pressure in the system during the pilot arc and cutting modes

Typical values would be:	For Pilot Arc	0.7 to 1.4 bar (10 to 20 psi)
	For Main Arc	2.4 to 3.4 bar (35 to 50 psi)

## AIR REGULATOR

Sets the air flow through the torch to give a stable pilot arc.

### 5.1.1 WARNING INDICATORS

See section 7.1.2 Displays and Controls for more details.

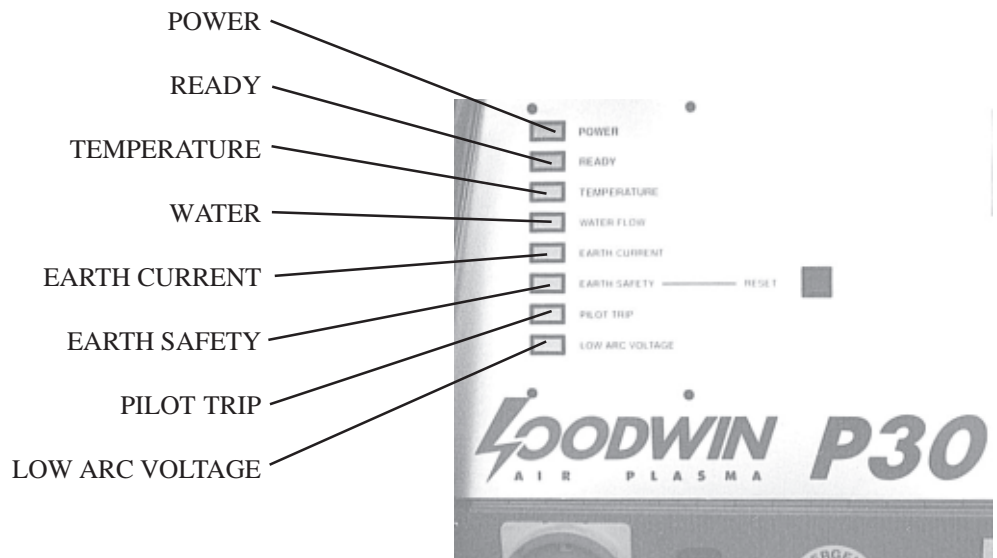

#### POWER INDICATOR -

Indicates that power is available to the system control circuit.

#### READY INDICATOR -

Indicates system interlocks are operational and the machine is ready to cut

#### TEMPERATURE INDICATOR -

Indicates that the rectifier or transformer temperature is too high.

#### WATER INDICATOR -

Indicates insufficient water flow in the torch.

#### EARTH CURRENT INDICATOR -

Indicates excessive currents in the supply earth (see section 3.2).

#### EARTH SAFETY INDICATOR -

Indicates a break in the earth connection to the torch or a voltage in excess of 10 volts to the torch body.

#### PILOT TRIP INDICATOR -

Indicates the pilot arc has excessive current, due to consumable condition or insufficient air flow.

#### LOW ARC VOLTAGE INDICATOR -

Indicates the arc voltage is too low, due to consumable condition or insufficient air flow.

## 5.2 Power Up Procedure

Having completed the mains and cutting earth wiring, connected the torch and checked the fan rotation, the machine is ready for use.

Switch the machine on and after allowing time for the water to circulate through the torch, press the reset button on the front panel. The red indicators should go out and the ready light will illuminate.

To ascertain the absence of air leaks, the air regulator should be wound fully clockwise and the pressure gauge should indicate a back pressure in excess of 1.6 bar.

It is now necessary to adjust the air pressure to give the highest possible reading consistent with good arc starting and a stable pilot arc, this should be around 0.9 bar. Switch on the torch with the nozzle well clear of any work piece, person or equipment, and re-adjust the air pressure until it is at maximum or the pilot arc becomes unstable (very noisy, misfire, and the voltmeter showing 300 volts). At this point reduce the pressure to restore stability (arc less noisy, stable arc, and the volt meter showing 250/280 volts).

Always maintain as high an air pressure as possible for pilot arc as this gives the best consumable life.

The output neon is “on” and the voltmeter reads between 250 vdc and 280 vdc at this stage.

The machine is now setup and is now ready to be used. Before starting a cut please see section 1 for safety information and then section 5.3 for cutting procedure.

### NOTE.

As plasma power units do not have a voltage stabilised power supply, a fluctuation in the input voltage will directly affect the output current. This may not be noticeable if the input voltage rises slightly above the norm as it will provide more power for cutting. If the rise is excessive, consumable life may suffer. However, when the input voltage falls, the output power also falls, affecting both the pilot arc and main arc. In these circumstances it will be necessary to adjust the air pressure regulator to reduce the airflow to obtain a stable pilot arc, and readjust it when the mains voltage returns to normal.

## 5.3 Cutting

### Procedure

#### 5.3.1. Starting and Finishing a Cut.

Where possible it is better to start a cut at a plate edge or hole because the piercing process reduces consumable life.

Cuts can be started by either initiating the pilot arc and moving the torch into the proximity of the work piece, or by positioning the torch over the edge of the work piece and starting the pilot arc.

Materials with a capacity to absorb heat energy, especially thicker sections, require more care and technique when starting a cut. In these cases the cut will appear slow to start and pierce through the material. Once a cut is established then cutting speeds may be increased.

Cutting can be stopped either by releasing the torch switch, switching off the power, or by withdrawing from the workpiece (best done rapidly).

#### 5.3.2. Cutting With Stand Off.

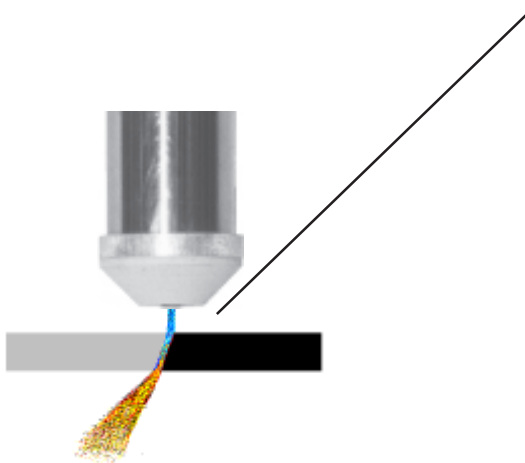

Under normal cutting conditions the torch is designed to operate with a STAND OFF of about 6 mm (except P50 8 mm). This is the distance between the end of the nozzle and the work piece.

Where the work piece is rusty, scaly, or with thick sections of steel or aluminium etc., a build up of dross on the top of the work piece may occur which will cause damage to the nozzle. In these conditions, the stand off distance should be increased slightly.

A guide ring is available to assist the operator in maintaining the desired stand off height. This can also be used against a straight edge to maintain a straight cut.

### IMPORTANT

If the arc should “flare”, be coloured green, or emit any unusual noise, it is recommended that the unit be immediately switched off and the condition of the consumables checked. Cutting under these conditions may result in damage extending beyond the consumables to other parts of the torch.

### 5.3.3. Cutting Speed.

Best results are usually obtained by cutting at the optimum cutting speed.



#### OPTIMUM CUTTING SPEED

Correct cutting speed is judged by experience from observing the angle at which the cut material leaves the lower edge of the plate, either by observing the ejected material or by studying the surface of a cut after completing a test cut. The drag back of the arc is approximately 30 degrees.



#### CUTTING TOO SLOW

Arc appears to blow straight through the material. Excessive dross may accumulate on the underside of the material.



#### CUTTING TOO FAST

Arc fails to pierce the material. Blow back of dross will damage the nozzle.



#### MAXIMUM CUTTING SPEED

Drag back of the arc is around 45°, but cut quality will deteriorate.



### 5.3.4. Piercing Thicker Materials with a Hand Torch

Piercing will cause cut material to be ejected upwards which can be dangerous, and has a risk of damaging the torch nozzle. This problem is worsened as material thickness increases because it takes longer to pierce. If it is necessary to pierce, then it is best done by angling the torch and gradually bringing it upright as piercing is completed.

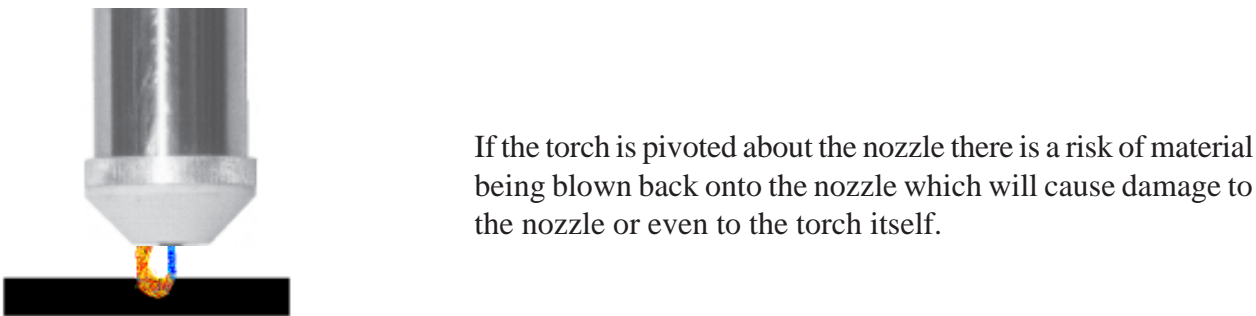
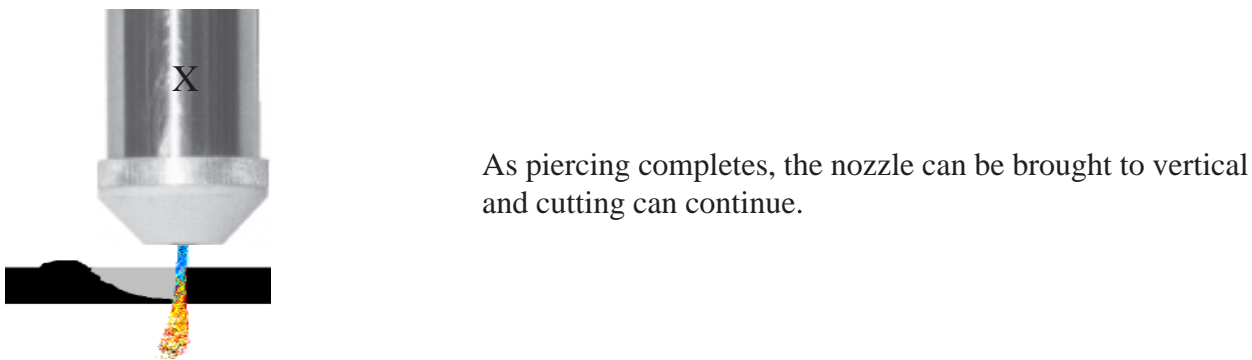
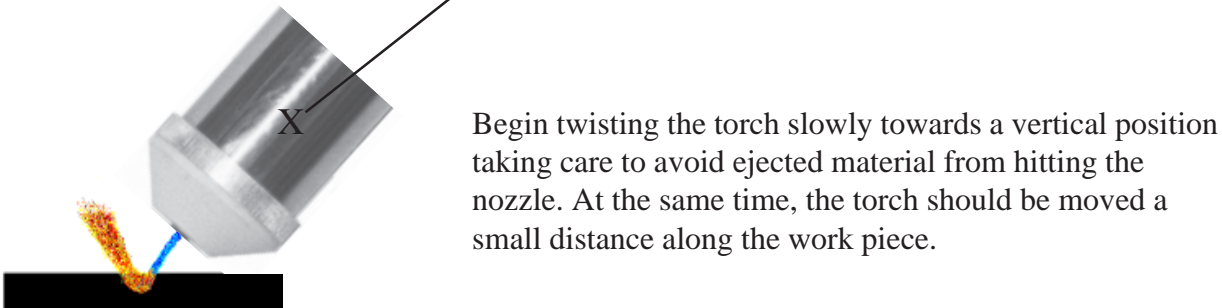
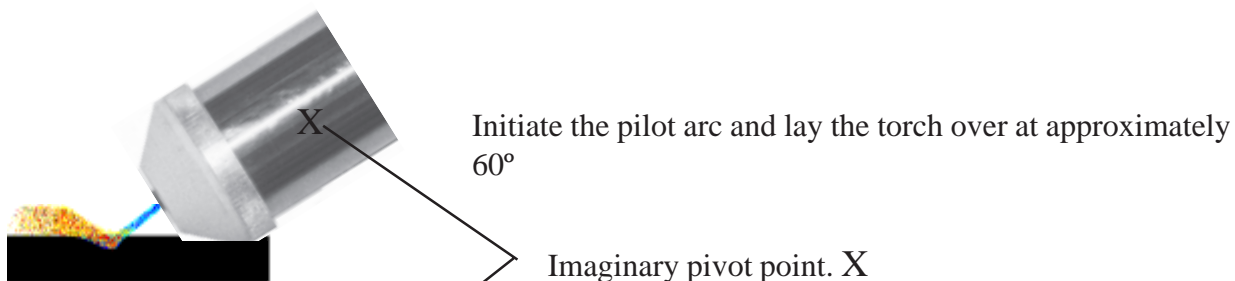

### 5.3.5. Piercing with a Machine Torch

When using a machine torch, it is not generally possible to angle the torch for piercing. Start the pilot arc above the work piece, and with the torch travelling at about half of the normal cutting speed, lower the torch until main arc transfer occurs. Once piercing is complete, the torch may be brought to normal stand off and cutting speed.

Goodwin Air Plasma offer an Automatic Height Control Unit as an optional extra for machine torches integrated with profiling machines or robot arms. Ask your distributor or Goodwin Air Plasma for further details.

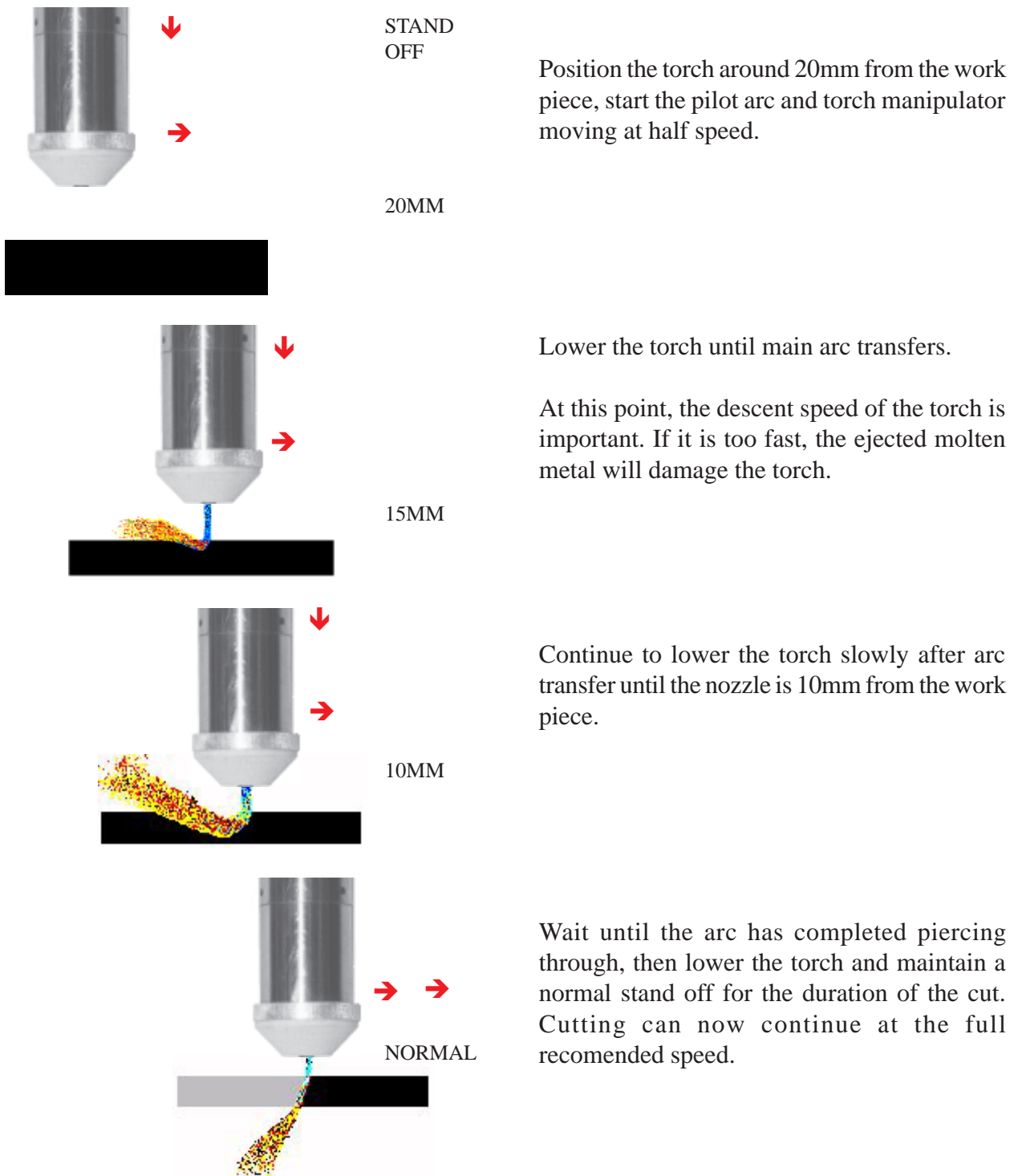

## 5.4

<b>Troubleshooting</b> edge of cut.	Cutting speed too slow. Torch consumables worn or damaged. Insufficient air flow.
Double arcing.	Damaged torch consumables. Nozzle blocked by dross or too close to work piece. Insufficient air flow.
Main arc not square to work piece.	Nozzle orifice damaged. Electrode eroded "off centre". Consumables wrongly fitted.
Excessive bevel or rounded cut surface.	Speed too high. Stand off too high. Arc not straight - consumables damaged or misaligned.

Bevel is more noticeable on thinner sections and is more pronounced on the left hand side of a cut. It is due to the clockwise swirling of the air induced by the swirl bush in the electrode assembly. Bevel edges can be desirable as an aid to weld preparation, however it can be virtually eliminated by reducing the cutting speed but at the expense of accumulated dross. For minimum bevel cut clockwise around a component and anticlockwise in a hole.

## 5.5. Consumable Life.

A good consumable life is the single most important factor in achieving optimum cutting economics of any plasma cutting unit. This life is dependent on the intrinsic life of the consumables, correct alignment and the incidence of transient and operational damage.

### 5.5.1. Intrinsic Life.

The intrinsic life of the consumables is determined by the rate at which they are eroded by the arc process. This erosion rate is however low, and in practice, the life is limited by other factors. The insert in the centre will be eroded slightly each time the arc is struck eventually creating a visible crater. The crater can be more than 2mm deep before the electrode is considered to be expired.

### 5.5.2. Alignment.

The alignment and construction of the Goodwin Air Plasma Torch is such that problems of grinding and adjusting electrodes do not occur. With reasonable care taken in fitting the consumables, alignment problems should not arise.

### 5.5.3. Transient Damage.

On starting directly onto main arc, it is occasionally possible to erode some of the copper from the electrode before the arc settles onto the insert material. This generates a crater in the electrode and the insert burns back to become flush. Consumable life is thus reduced if there is a high number of starts relative to the total cutting time.

#### 5.5.4. Operational Damage.

This is the most likely cause of limited consumable life. Since the arc is quite capable of cutting copper, anything which causes the arc to deviate from the centre of the nozzle will result in damage to the orifice. In extreme cases the arc passes not through the orifice but from the electrode to the nozzle and from the nozzle to the work piece - DOUBLE ARCING, causing the rapid erosion of copper from both electrode and nozzle.

The most common cause of these problems is from ejected cut material entering the orifice particularly when piercing or obstructing the nozzle with the work piece.

It is best to operate within the maximum speed capabilities of the machine and avoid unnecessary piercing or stop-start cutting whenever possible.

#### 5.5.5. Electrode “non-starting”.

Occasionally, it may happen that it is difficult to start the pilot arc. This happens when the oxidized material from the electrode insert is deposited over the surface of the copper electrode and inside the nozzle. Starting can be improved by cleaning or scratching the surface of the electrode with a wire brush or sharp implement. Always switch off the power unit before removing the nozzle for this purpose. Once a “non-starting” electrode has been used a few times, starting usually improves.

It is not good practice to fire the pilot arc continually in midair without striking the cutting arc as this oxidizes the surface of the electrode and leads to “non-starting” problems.

Since cutting usually improves a non-starting electrode, it may be desirable to use a piece of scrap material and start the main arc immediately by positioning the torch close to the material before switching on. Once started, continue to cut for as long as possible before trying to re-initiate the pilot arc.

#### ILLUSTRATION TO SHOW ELECTRODE DAMAGE

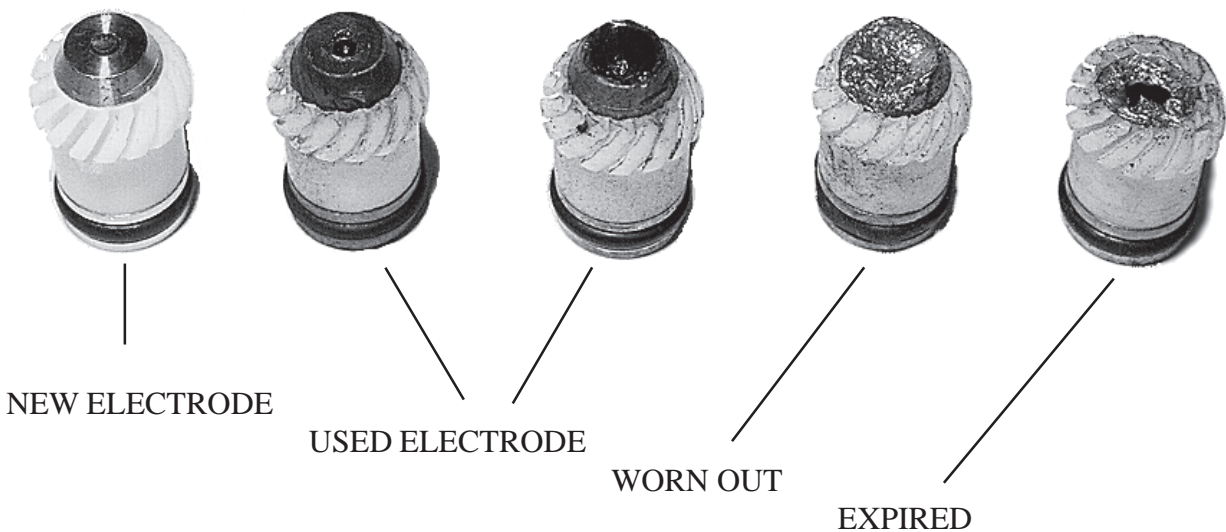

## 5.6 Changing Consumables

The Goodwin Water Cooled torch carries a number of elements known as the CONSUMABLES which are eroded during the cutting process. They consist of:

- a) Nozzle.
- b) Electrode Assembly comprising:
  - Electrode
  - Swirl Bush
  - O ring

Other parts that may be damaged and replaced by the user are:

Front Cap  
Front Cap Retaining Ring  
Contact Tube.

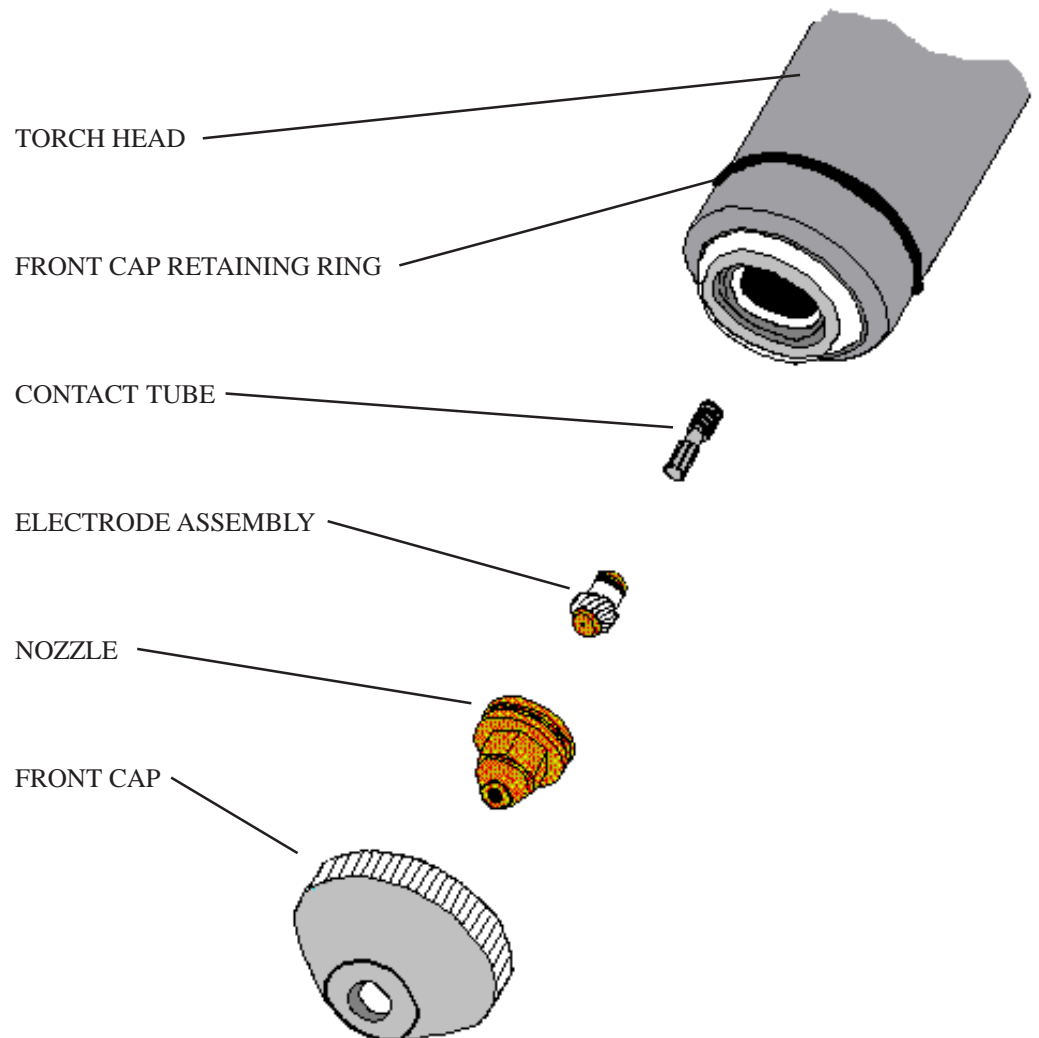

To renew the consumables, the following procedure should be adopted, remembering that care and cleanliness are of the utmost importance.

1. Switch the machine off at the mains supply or Main Isolator.
2. Remove the Front Cap. The cap is a push fit over the O ring seated in a groove in the outer diameter of the Torch Body.



3. Unscrew the Nozzle with the special tool supplied. (See illustration left).

4. Check the condition of the Electrode Assembly. If it is to be removed, grip the Electrode Assembly with the special Electrode Pliers provided, and pull firmly out from the torch body. (See illustration right).



5. Press a new Electrode Assembly carefully but firmly over the contact tube until it is fully home and central. Use the handle of the Nozzle Tool which has been prepared for this purpose. **THIS IS VERY IMPORTANT !** If the Electrode is not pressed fully home onto the Contact Tube, the Swirl Bush may be partly crushed by the Nozzle, and will interfere with the airflow.
6. Carefully screw the Nozzle into the Torch Head using the special tool until fully home. **DO NOT OVER TIGHTEN.**
7. Apply a liberal quantity of Silicone Grease around the front of the torch.
8. Refit the push fit Front Cap. Apply additional grease over the outside of the front cap. The grease will provide a first line of defence against material blown back from the cutting process.

Remember that cleanliness and care must be taken when fitting consumables. Do not allow dirt to obstruct the threaded parts of the torch. Take care when engaging threaded parts not to damage the thread.

#### CONTACT TUBE REPLACEMENT.

Should the Contact Tube need changing, it is removed by inserting the 1/8" allen key supplied into the centre and unscrewing. Replacement is the reverse of removal but **it is important not to over tighten** as this may cause subsequent electrode fitment to be off centre, producing bevel cuts.

## 6. TECHNICAL DATA

### 6.1 Power Unit

#### 6.1.1. Electrical Input

Input is via 3 core and earth flexible: 4 x 10mm<sup>2</sup> 3 metre length standard.

Machines are available for the following 3 phase supplies:

**Note.** When the power unit is connected to a generator it may be necessary to disconnect the power factor correction capacitors in the power unit if they disturb the generator's automatic voltage control. This does however increase the demand at full power.

Input Voltage		With PF Correction	Without PF Correction
380v	50Hz	58 amp	90 amp
415v	50Hz	53 amp	85 amp
460v	60Hz	48 amp	83 amp
Other voltages and frequencies available to order			

#### 6.1.2. Electrical Output

Open circuit voltage	300v dc
Typical arc voltage	150v dc
Main arc power	30kW
Pilot arc current	15 - 20 amps nominal
Duty cycle	100%

#### 6.1.3 Miscellaneous

Compressor type	Oil free twin cylinder.
Water pump type	Regenerative type.
Water capacity	3 litre (approx. dependant on hose length) distilled or deionised water

#### 6.1.4. Dimensions

Length	800mm	(26") inc wheels and handle.
Width	700mm	(22") "
Height	1200mm	(48") "
Weight	302 kg	( 666 lb)

## 6.2 Torch and Hose Set

#### 6.2.1 Hand Torch

Torch body diameter	40mm
Torch head weight	1.0 kg
Effective weight (inc. hose set)	1.5 kg
Hose set lengths available	7.5m, 15m, 20m, 30m, longer with Junction Box.
Hose set water capacity	0.6 litres per 10m length

## 7. SERVICE INFORMATION

### 7.1 The Power Unit

Output power is supplied from a fan cooled transformer and rectifier with varistor diode protection. The transformer is rated at 100% duty cycle and is protected by a thermostat.

The power is carried to the torch electrode by a cable within the hose set.

Pilot arc connection to the nozzle is made via a current limiting resistor in the rear of the machine and a coaxial cable in the hose set. The HF arc ignition is fully automatic in operation, being powered from the torch power lines.

The compressor, cooling fan, and water pump are the only “phase sensitive” components and it is essential to ensure that their direction of rotation is correct according to the installation instructions (see section 3).

These components are protected by thermal / magnetic overload switches. If an overload should operate, after establishing the reason for the trip (e.g. missing supply phase). It can be reset by first removing the machine cover then pressing the manual reset button on the overload unit situated behind the instrument panel.

The transformer, water radiator and the pilot arc resistor, are cooled by an electric fan. A temperature sensing interlock inside the transformer windings protects the system against thermal overload should the cooling fail or be obstructed hence it is essential to ensure adequate air circulation around the machine at all times.

The air compressor is of the oil free, maintenance free, twin piston type fitted with two cleanable/replaceable inlet filters contained in black screw-in housings with a snap open lids.

The high pressure water pump supplies cooling water to the torch through quick release, self sealing couplings so that the torch can be disconnected without the loss of water from the system. There is an interlocked flow sensor on the return line which shuts down the arc if the water flow should be restricted.

The header tank must be kept full of distilled water at all times. If site conditions dictate that antifreeze should be used, then up to 33% METHANOL may be added.

**NOTE.** Ethylene glycol or automotive type antifreeze fluids **MUST NOT BE USED**, as they will cause rapid corrosion of the torch.

Whenever any of the interlocks come into operation the appropriate warning light on the front panel will indicate to assist in the diagnosis of the problem.

#### 7.1.1. Main Circuits and Systems.

The Circuit Diagram is shown in drawing 1/D/10749



### 7.1.1. Circuit Diagram

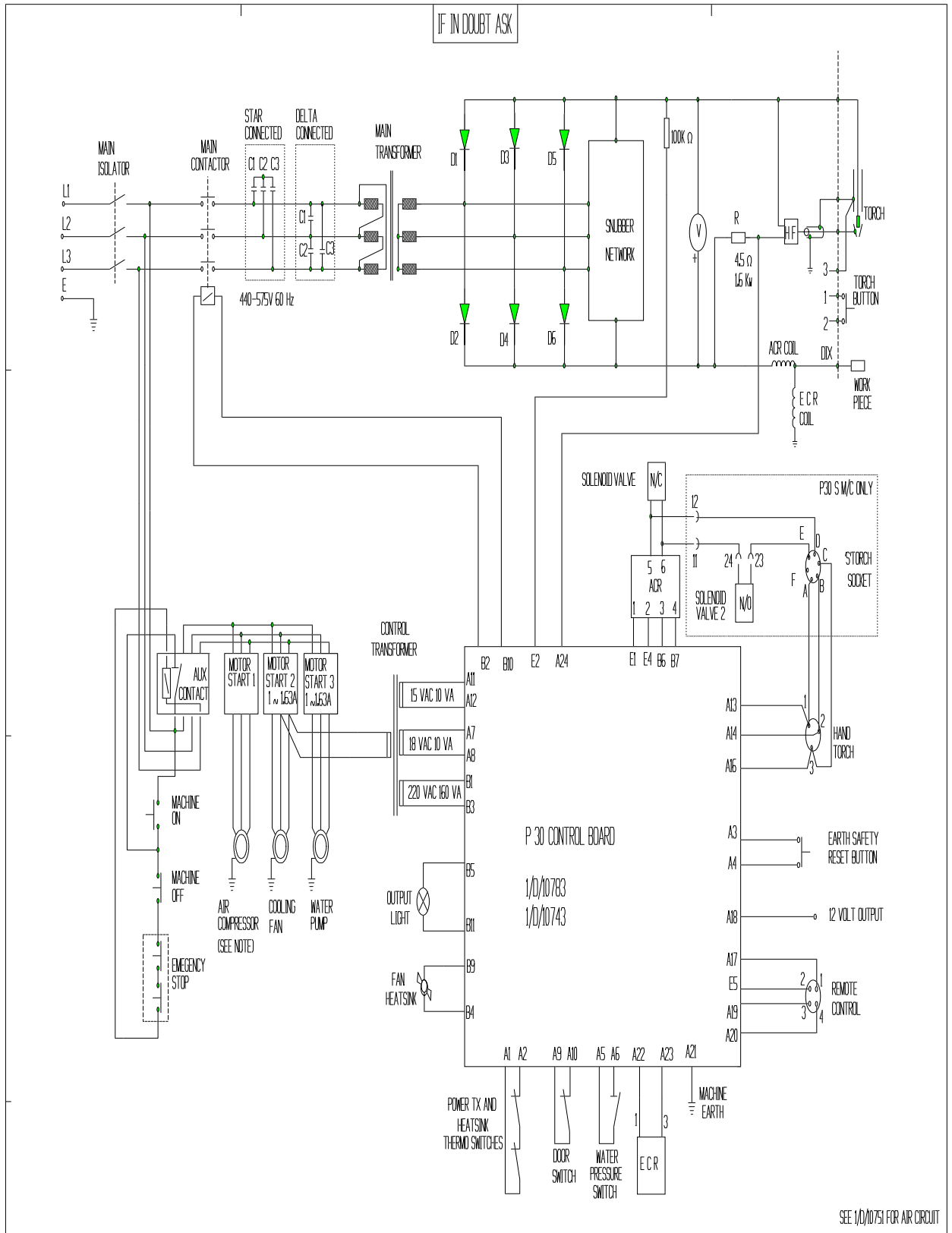

SEE 1/D/10751 FOR AIR CIRCUIT

THIS DRAWING IS THE PROPERTY OF GOODWIN AIR PLASMA LTD. IT IS STRICTLY CONFIDENTIAL, AND MUST NOT BE COPIED, LOANED, OR DISCLOSED TO OTHER PARTIES WITHOUT THEIR PERMISSION. COPYRIGHT IS STRICTLY RESERVED.

UNLESS OTHERWISE STATED  
ALL TOLERANCES:

DIMENSIONAL SQUARENESS 0.1  
ROUNDNESS 0.1  
CONCENTRICITY 0.1

ISSUE	DATE	CHECKED	REQUESTED	CHANGE

**GOODWIN AIR PLASMA Ltd.**  
KERNAN DRIVE, LOUGHBOROUGH, LEICESTERSHIRE LE11 5JF Tel.01509 237369 Fax.01509 234942

ALL DIMENSIONS IN MILLIMETRES

NOT TO SCALE

MATERIAL  
SPEC  
DRAWN BY BARRY HALL  
DATE 26.02.98

TITLE **P30**  
CIRCUIT DIAGRAM  
Dwg No. 1/D/10749

### 7.1.2. Machine Layout

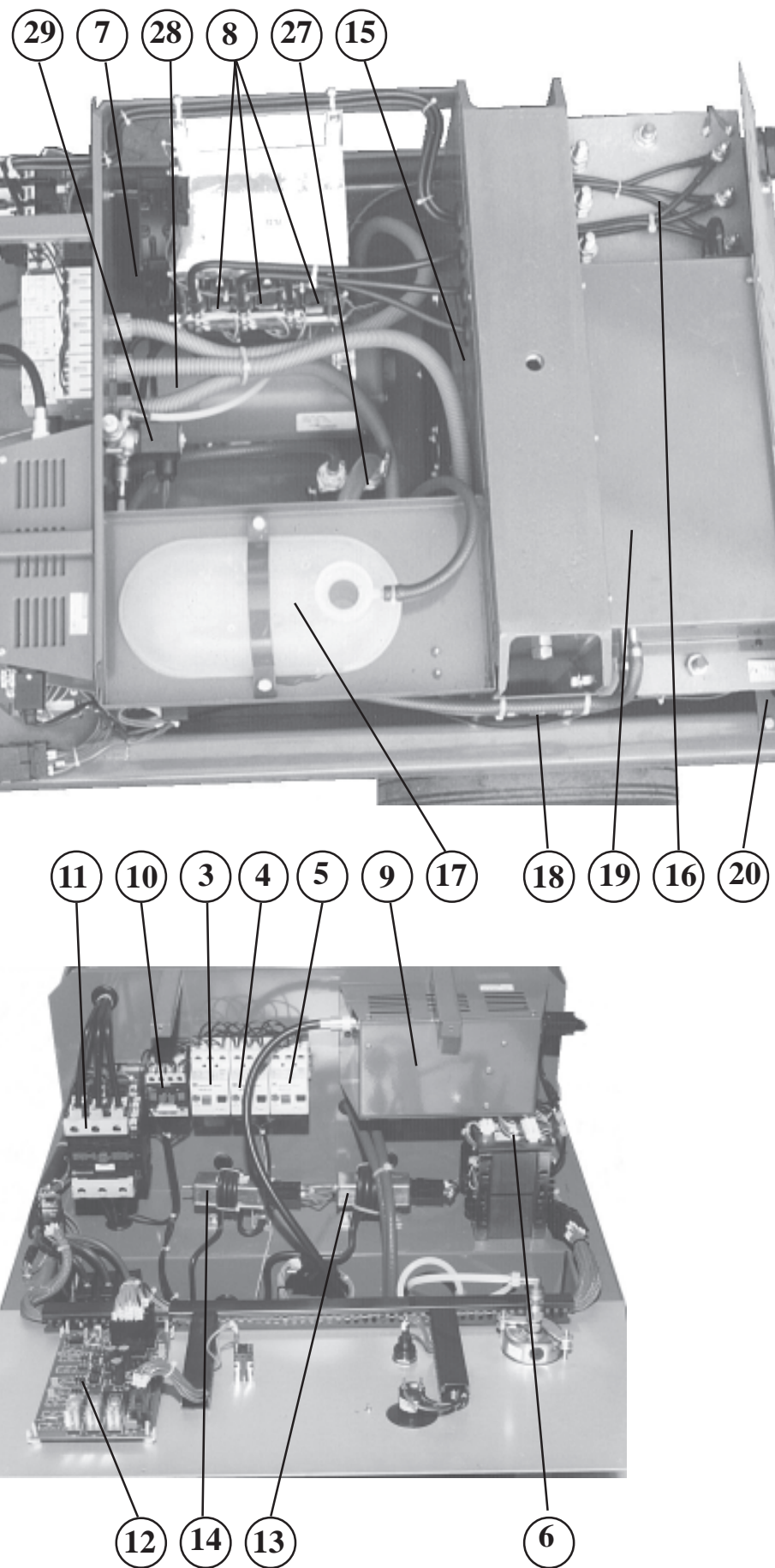
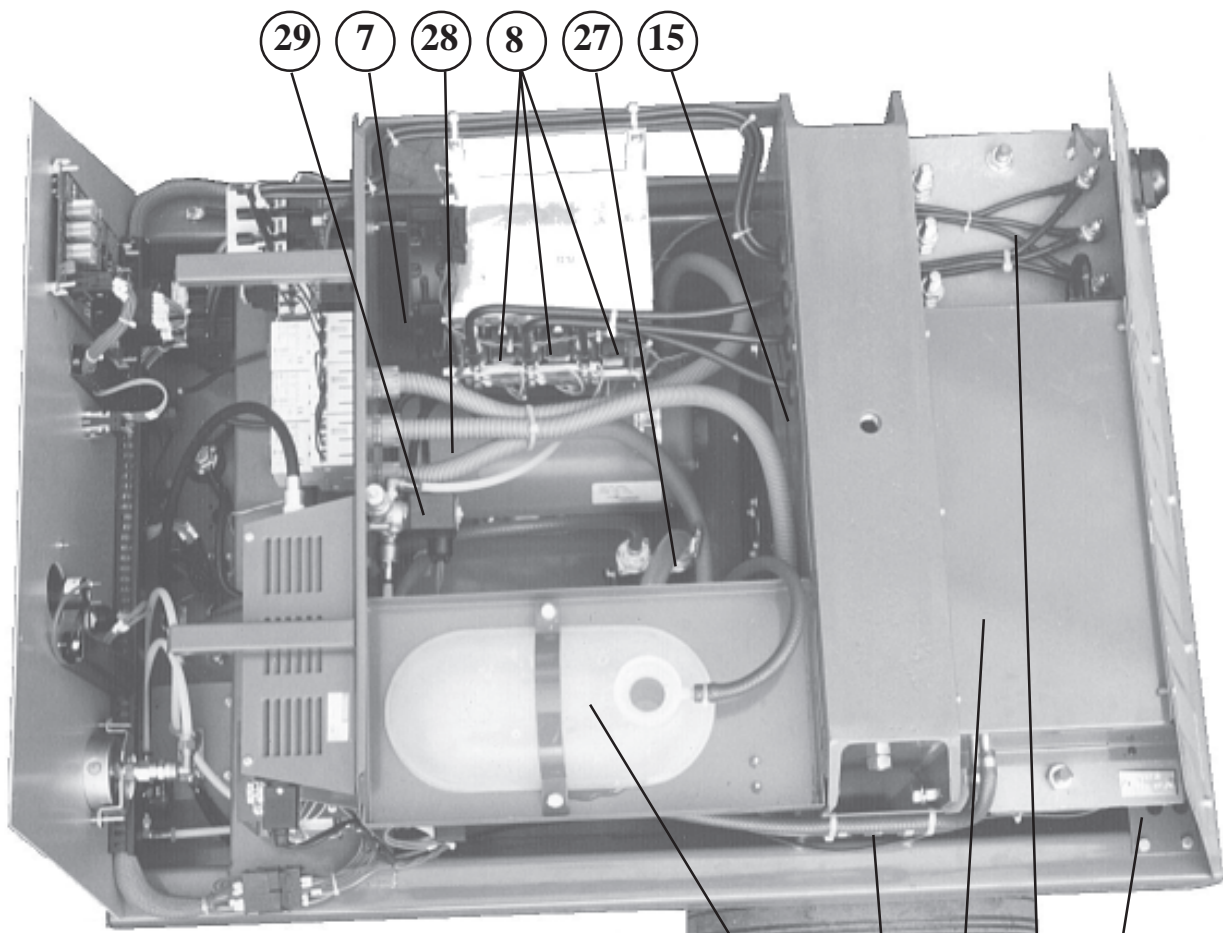

## PARTS LIST

## PART NUMBERS

1 .....	Volt Meter	PX52MV300S
2 .....	Main Isolator	PX50IS99F
3 .....	Motor Starter Compressor	PX50CM025
4 .....	Motor Starter Fan	PX50CM010
5 .....	Motor Starter Water Pump	PX50CM016
6 .....	Control Transformer	PX56A200
7.....	Compressor Filters	PX57CXT01
8 .....	Diodes	PX54S0029
9 .....	H F Box	PX68MFI0870
10 .....	Aux Contactor	PX50CA09
11.....	Main Contactor	PX50CA80
12 .....	Control P C Board	PX55C10782A
13 .....	Arc Current Relay	PX68MF10323
14 .....	Earth Current Relay	PX68MF10565
15 .....	Fan	PX57FA300
16 .....	Main Transformer	PX56M30+VOLTAGE
17 .....	Water Tank / Cap	PX63T10833/PX63M004
18 .....	Water Pressure Switch	PX50SA01
19 .....	Radiator Assembly	TO ORDER
20 .....	Pilot Arc Resistor	PX54R0067
21 .....	Air Pressure gauge	PX28100G
22 .....	Output Neon	PX52BN240A12
23 .....	Air Pressure Regulator	PX29R08
24.....	Stop/Start Switch	PX50SP00Z
25.....	Emergency Stop Switch	PX50SP001
26.....	Reset Switch	PX50SP01
27.....	Water Pump	PX57W500
28 .....	Compressor	PX57C400
29 .....	Solonoid Valve	PX29VS99
(Not Shown).....	Dix Connector	PX4201RD300S
(Not Shown).	Power Factor Correction Capacitor	PX54C0038
(NS) ..(Water fitting, Return)	Mini Check Unit Long	PX29V01
(NS) ....(Water fitting, Feed)	Mini Check Unit Short	PX29V10829

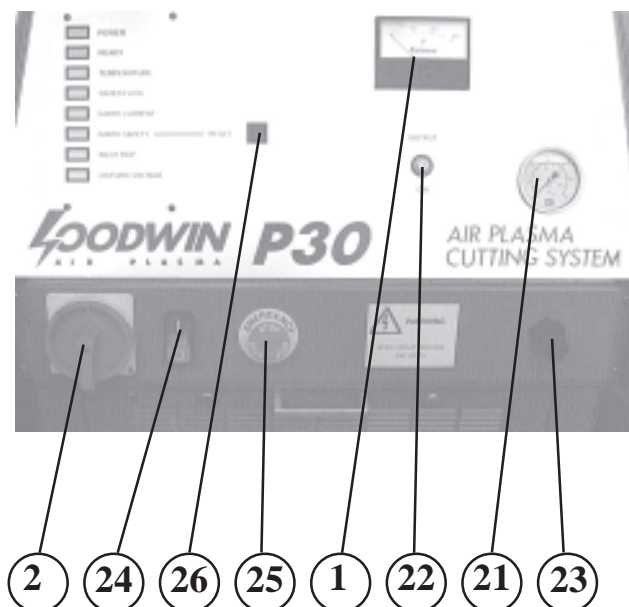

## 7.1.2. Diagnostic Indicators.

### OUTPUT ON LAMP

Indicates that power is applied to the torch.

### POWER INDICATOR

Indicates that 12V power is available to the system control circuit.

### READY INDICATOR

Indicates that all system interlocks including the access door are operational and that the machine is ready to operate.

### TEMPERATURE INDICATOR

Indicates that the rectifier heatsink and / or main transformer temperature is too high. Cutting operations will immediately stop. Leave the machine running to allow the fan to cool the transformer. Systems will automatically reset when the temperature drops.

### WATER INDICATOR

Indicates no water in the system, a water leak, torch blockage, low pump supply pressure or incorrect motor/fan rotation. See section 7.2 for torch blockage. When water flow is restored, the system will reset automatically.

### EARTH CURRENT INDICATOR

Indicates the main arc cutting current is flowing in a secondary path. System will stop until the torch switch is released. (See section 3.2 for cutting earth requirements).

### EARTH SAFETY INDICATOR

Indicates a break in the earth connection to the torch or a voltage in excess of 10 volts to the torch body. This indicator will also illuminate as a self test when the machine is switched, on Depressing the RESET button will reset the system provided the fault is rectified.

### PILOT TRIP INDICATOR

Indicates the pilot arc has excessive current. The circuit will reset automatically when the torch switch is released. Check air flow adjustment, air leaks, restricted air flow, or consumable condition.

### LOW ARC VOLTAGE INDICATOR

Indicates the arc voltage is too low. System will latch out until the torch switch is released. Check consumable condition and for air leaks or restricted air flow.

## 7.2 The Torch and Hose Set Repair

The torch is a precise assembly of electrically conductive parts and P.T.F.E. insulators housed in a stainless steel body. It is supplied with compressed air, water and electrical power at high voltage which must not be allowed to escape from their designed confines.

Rebuilding torches requires special training and instruction and is not within the scope of this manual. Users who wish to repair damaged torches themselves should consult their supplier or Goodwin Air Plasma for detailed advice.

A torches should be removed from the power unit complete with hose set. Once removed, the torch head may be serviced or repaired.

If a spare torch and hose set is available, the machine may be put back in service whilst repairs are carried out.

### TORCH BLOCKAGE.

The water flow in the torch can occasionally become blocked, usually with scale because deionised / distilled water has not been used or has become contaminated. Also, copper deposits can accure as a result of expiry of an electrode. See section 8 of this manual.

### TORCH / HOSE JUNCTION BOX ON MACHINE INSTALLATIONS .

A Junction box is offered as an optional extra to provide a facility for the fast removal of the torch head. Useful for service or change of use with minimum loss of production time, the junction box links all the control services carried by the hose set to the torch. Another advantage of the junction box is that it will allow the majority of the hose set, which may be lengthy and difficult to remove from an automatic machine, to remain in situ.

## 7.3 Maintenance

<b>Daily</b>	Check condition of the consumables. Top up water reservoir with distilled / demineralised water.
<b>Monthly</b> (depending on usage)	Check for water and air leaks, clean the air compressor intake filters. Remove excessive dust from inside the machine taking care not to damage any mechanical or electrical component and avoid exposure to this dust which may represent a health hazard. Use personal protection as necessary.
<b>Annually</b> more frequently in poor conditions or with high usage	Replace the compressor air intake filter. Check tightness of all electrical and mechanical connections. Check the correct operation of all controls and indicators.

Goodwin Air Plasma Cutting Systems are designed so that only a minimum amount of maintenance is required. By following a regular and careful maintenance procedure, the equipment will give a long productive life.

## 8. Torch Blockage

The torch can become blocked if deionised / distilled water is not used, or with copper deposits when the electrode expires. In both cases the blockage accrues in the Cathode Block, Centre Insulator and Nozzle Holder. The torch head will need to be partially dismantled to rectify this condition. This operation must only be carried out by a competent electrical fitter.

### 8.1 Machine Torch

1. Remove the Nozzle and Electrode.
2. Remove three small grub screws from mounting tube.
3. Take care not to strain pipe connections to the torch.
4. Pull back the mounting tube and bagging to reveal all the connections of the hose set.
5. Remove safety insulator by carefully cutting with a sharp knife, taking care not to cut the insulation of the wires inside.
6. Unscrew torch body off the stub tube, put stub tube clear of torch head, and remove Front Insulator.
7. Slide Back Cover up the Air/Power and Water Pipes to reveal HF Strap and HF Screws.
8. Using a small flat bladed screw driver unscrew the two screws. This will allow the Nozzle Holder to be removed.
9. Carefully ease out the Centre Insulator taking care not to lose the four Water Seals. This will reveal the Cathode Block.
10. Clean out the two water galleries using a small drill bit by hand, taking care not to push the blockage any further into the Cathode Block.
11. Clean holes in the Centre Insulator in the same way.
12. The Nozzle Holder is cleaned in the same way, however this may have a blockage within the circular water gallery, (check this by blowing into one of the holes, if the air flows freely it is ok to re-use) if it is blocked it will need replacing before rebuilding the torch.
13. Check Water Seals for damage. Replace if necessary and refit into Centre Insulator.
14. Check length of HF screws as they may have stretched. If they are over 35mm they should be replaced.
15. Refit Centre Insulator to Cathode Block taking care not to dislodge Water Seals.
16. Refit Nozzle Holder to Centre Insulator taking care to align screws with threaded holes and tighten.
17. Pull back the Back Cover and Stub Tube taking care to align the two anti-rotation pins with holes in Back Cover and ensure the Black, Green/Yellow (Earth) and Red (HF) wires are together.
18. Refit Front Insulator over Nozzle Holder, if this is damaged replace it.
19. Refit Torch Body over torch and screw onto Stub Tube taking care not to cross thread.
20. Fit new Safety Insulator by heat shrinking into place or taping the old one into place taking care to cover all the exposed metal torch parts.
21. Pull back the Mounting Tube and refit the three grub screws.
22. Refit the Nozzle and Electrode to the torch.
23. Remove water return pipe connection from the Machine (Long water fitting) and start Machine, allow water to run out until the air lock is released (the water jet will stop then restart). Run machine for a further five seconds, this will allow any debris left in the torch head to be ejected. Switch off Machine and reconnect hose set.

**NOTE:-** If the jet of water coming out of the removed return water connection is not between 300 to 500mm long then the torch may still be blocked and should be stripped down completely or sent to Goodwin Air Plasma for repair.

## 8.2 Machine Torch exploded View

VIEW OF REAR OF CATHODE BLOCK  
TO SHOW LOCATION OF WATER AND AIR PIPES

ITEM	PART No.	DESCRIPTION	DRAWING
01	PCFW02	FRONT CAP	1/D/00291
02	PCR35	FRONT CAP RETAINING RING	1/D/00063.04
03	PC***	NOZZLE (SEE INSET J)	1/D/00293
04	PCE01	ELECTRODE ASSEMBLY	1/D/00312
05	PCC01	CONTACT TUBE	1/D/00330
06	PTXW1M	MACHINE TORCH BODY	1/D/00214
07	PTXW02	FRONT INSULATOR	1/D/00197
08	PTXW03	NOZZLE HOLDER	1/D/00192
09	PTXW04	WATER SEAL O RING	1/D/00063.03
10	PTXW05	CENTRE INSULATOR	1/D/00510
11	PTXW06M	CATHODE BLOCK	1/D/00189
12	PTXW07M	REAR INSULATOR	1/D/00211
13	PTXW09	H.F. SCREW INSULATOR	1/D/00314.04
14	PTXW08M	H.F. STRAP	1/D/00234
15	PTXW10	H.F. SCREW	
16	PTXW12M	REAR COVER	1/D/00301
17	PTXW26M	SLUB TUBE	1/D/00292
18	PTXW27M	SLTD CSK TERM. SCREW	
19	PTXW15	WATER FEED PIPE ASSY	1/D/00401.02
20	PTXW16	SLEEVE NUT	1/D/00068
21	PTXW14	WATER FEED PIPE INSULATOR	1/D/00314.01
22	PTXW18	WATER RETURN PIPE ASSY	1/D/00401.03
23	PTXW17	WATER RETURN PIPE INSULATOR	1/D/00314.05
24	PTXW20	AIR POWER PIPE ASSY	1/D/00401.01
25	PTXW19	AIR POWER PIPE INSULATOR	1/D/00314.02
26	PTXW28M	MOUNTING TUBE	1/D/00215
27	PTXW29M	MOUNTING TUBE GRUB SCREW	

IF IN DOUBT ASK

THIS DRAWING IS THE PROPERTY OF GOODWIN AIR PLASMA LTD, IT IS STRICTLY CONFIDENTIAL, AND MUST NOT BE COPIED, LOANED, OR DISCLOSED TO OTHER PARTIES WITHOUT THEIR PERMISSION. COPYRIGHT IS STRICTLY RESERVED.

ISSUE DATE 7 6/5/98

CHECKED P.H.

REQUESTED

PART NUMBERS CHANGED.

\*\*\* PCN50 P50 NOZZLE 1/D/00293.02

\*\*\* PCN30 P30 NOZZLE 1/D/00293.03

\*\*\* PCN20 P20 / P18 NOZZLE 1/D/00293.01

CHANGE

ALL DIMENSIONS IN MILLIMETRES

NOT TO SCALE

TITLE EXPLODED VIEW OF  
WATER COOLED MACHINE TORCH  
(PTWM)

MATERIAL

SPEC

DRAWN BY P.W

DATE 26/11/85

DRG No. 1/D/00158

# GOODWIN AIR PLASMA Ltd.

KERNAN DRIVE, LOUGHBOROUGH, LEICESTERSHIRE LE11 5JF  
 Tel: 01509 237369  
 Fax: 01509 234942



### 8.3 Hand Torch

1. Remove the Front Cap, Nozzle and Electrode.
2. Remove Back Cap and Front Ring (using Special tool).
3. Remove Rear Cover by carefully tapping the side of the Torch on a piece of wood, this will cause it to fall out. This will reveal the HF Strap and HF Screws.
4. Using a small flat bladed screw driver unscrew the two screws. This will allow the Nozzle Holder to be removed.
5. Carefully ease out the Centre Insulator taking care not to lose the four Water Seals. This will reveal the Cathode Block.
6. Clean out the two water galleries using a small drill bit by hand, taking care not to push the blockage any further into the Cathode Block.
7. Clean holes in the Centre Insulator in the same way.
8. The Nozzle Holder is cleaned in the same way, however this may have a blockage within the circular water gallery, (check this by blowing into one of the holes, if the air flows freely it is ok to re-use) if it is blocked it will need replacing before rebuilding the torch.
9. Check Water Seals for damage. Replace if necessary and refit into Centre Insulator.
10. Check length of HF screws as they may have stretched. If they are over 35mm they should be replaced.
11. Refit Centre Insulator to Cathode Block taking care not to dislodge Water Seals.
12. Refit Nozzle Holder to Centre Insulator taking care to align screws with threaded holes and tighten.
13. Refit Front Insulator over Nozzle Holder, if this is damaged replace it.
14. Refit Front Ring and Back Cap taking care not to cross thread.
15. Fit Nozzle and Electrode to torch.
16. Remove water return pipe connection from the Machine (Long water fitting) and start Machine, allow water to run out until the air lock is released (the water jet will stop then restart). Run machine for a further five seconds, this will allow any debris left in the torch head to be ejected. Switch off Machine and reconnect hose set.

**NOTE** If the jet of water coming out of the removed return water connection is not between 300 to 500mm long then the torch may still be blocked and should be stripped down completely or sent to Goodwin Air Plasma for repair.

# 8.4 Hand Torch exploded View

IF IN DOUBT ASK

ITEM	PART No.	DESCRIPTION	DRAWING
01	PCGW01	GUIDE RING AND INSERT ASSY	1/D/10273
02	PCGW99	GUIDE RING INSERT	1/D/10274
03	PCFW02	FRONT CAP	1/D/10291
04	PCR35	FRONT CAP RETAINING O RING	1/D/10063 04
05	PC***	NOZZLE (SEE INSET)	
06	PCE01	ELECTRODE ASSEMBLY	1/D/10312 01
07	PCC01	CONTACT TUBE	1/D/10330
08	PTXM01H	FRONT RING	1/D/10302
09	PTXM02	FRONT INSULATOR	1/D/10197
10	PTXM03	NOZZLE HOLDER	1/D/10192
11	PTXM04	WATER SEAL O RING	1/D/10063 03
12	PTXM05	CENTRE INSULATOR	1/D/10510
13	PTXM06H	CATHODE BLOCK	1/D/10188
14	PTXM07H	REAR INSULATOR	1/D/10209
15	PTXM09	HF. SCREW INSULATOR	1/D/10314 04
16	PTXM08H	HF. STRAP	1/D/10233
17	PTXM10	HF. SCREW	

18	PTXM21	HF TERMINAL SCREW	
19	PTXM11H	HAND TORCH BODY	1/D/10145
20	PTXM12H	REAR INSULATOR COVER	1/D/10212
21	PTXM13H	BACK CAP	1/D/10213
22	PTXM14	WATER FEED PIPE INSULATOR	1/D/10314 01
23	PTXM15	WATER FEED PIPE ASSY	1/D/10401 02
24	PTXM16	SLEEVE NUT	1/D/10068
25	PTXM17	WATER RETURN PIPE INSULATOR	1/D/10314 05
26	PTXM18	WATER RETURN PIPE ASSY	1/D/10401 03
27	PTXM19	AIR POWER PIPE INSULATOR	1/D/10314 02
28	PTXM20	AIR POWER PIPE ASSY	1/D/10401 01

PART No.	APPLICATION	DRAWING
05	PCN50	P50
05	PCN30	P30
05	PCN20	P20 / P18

ISSUE	DATE	CHECKED	REQUESTED	CHANGE
10	6/5/98	P.H.		PART NUMBERS CHANGED

TITLE	
EXPLODED VIEW OF	WATER COOLED HAND TORCH (PTMH)

MATERIAL	DATE	DRG No.
ALL DIMENSIONS IN MILLIMETRES	06/8/93 R.M.	1/D/10438

DATE	DRAWN BY
6/5/98	P.W

NOT TO SCALE

THIS DRAWING IS THE PROPERTY OF GOODWIN AIR PLASMA LTD. IT IS STRICTLY CONFIDENTIAL, AND MUST NOT BE COPIED, LOANED, OR DISCLOSED TO OTHER PARTIES WITHOUT THEIR PERMISSION. COPYRIGHT IS STRICTLY RESERVED.

## GOODWIN AIR PLASMA Ltd.

KERNAN DRIVE, LOUGHBOROUGH, LEICESTERSHIRE LE11 5JF Tel:01509 237369 Fax:01509 234942

## 9. Fault Finding

Below is a list of the most common reasons for **non operation** of a Goodwin Air Plasma Cutting System.

Symptom	Probable cause	Remedy
No Pilot arc at torch head when torch button is depressed	a) Machine Ready Light not on b) Output Indicator not on	Check for red indicator being on (If so refer to Manual) Check torch switch and 220v fuse
As above with output indicator on	c) Non starting electrode	(Refer to manual)
As above with volt meter reading 285v	d) Volt meter not reading 285v e) No HF in HF box f) Broken HF cable on hose set	Telephone Goodwin Air Plasma Telephone Goodwin Air Plasma Telephone Goodwin Air Plasma
Current trip indicator coming on	a) Electrode incorrectly fitted b) Low air flow through torch c) A path to mains earth	Refit correctly Increase flow, check for air leaks Ensure workpiece is completely isolated from mains earth
Pilot trip indicator coming on	a) See Above b) None of the above	Telephone Goodwin Air Plasma
Low arc voltage indicator coming on	a) Air leak in torch or machine	Find the leak
Misfiring pilot arc	a) Too much air flowing through torch b) Blown diode	Decrease flow Telephone Goodwin Air Plasma
Tracking :- Spark appears at front of torch and no pilot arc.	a) Slag build up on Front Cap b) Front Insulator damaged	Clean slag from around Nozzle Replace Front Insulator
Front Caps and Nozzles burning up rapidly	a) Incorrect operation of torch b) Not using Silicone Grease	See operating instruction pages Apply Silicone Grease
Excessive bevel, poor cut quality	a) Damaged Consumables b) Electrode eroded off centre c) Misaligned Consumables d) Low air pressure e) Cut speed too fast f) Stand off too high	Change Consumables Change Consumables Change Contact Tube and consumables Clean air filters, check for air leaks See operating instruction pages See operating instruction pages

# 10.

# Index

## A

Accessory  
Junction box 29

## C

Consumable  
Life of 19, 20  
Cutting  
Bevel 19  
Blow back 20  
High Frequency (HF) 6  
Main arc 6  
Pilot arc 6  
Process explained 6  
Robot 4  
Ventilation 4  
Water table 4

## E

emergency 5

## F

Fault Finding  
Bevel 19  
Dross 19  
Troubleshooting 19

## G

Goodwin Air Plasma 2  
Guide Ring 15

## H

Health and Safety 2

## P

Plasma  
Process 4

## S

Safety  
General 4  
Mains connection 4  
Noise 4  
Personal protection 4  
Service  
Hose 29  
Torch 29  
Torch blockage 29

## T

Training 4